

9113 Emptying system Semco 180 ml



7002-0004 Level sensor



5015 2-Way ball valve



5015-02 Ball valve with quick release and safety sheet

Description

Pneumatic emptying system for Semco cartridges 180 ml.

With folding mechanism for replacing the cartridges. The setting on the pressure gauge changes the pressure on the cartridge and thus the flow rate.

Connection options for different dosing valves such as e.g. Dispenser via a material tube.

9113 Emptying system Semco 180 ml

Dimensional drawing (Dimensions in mm)

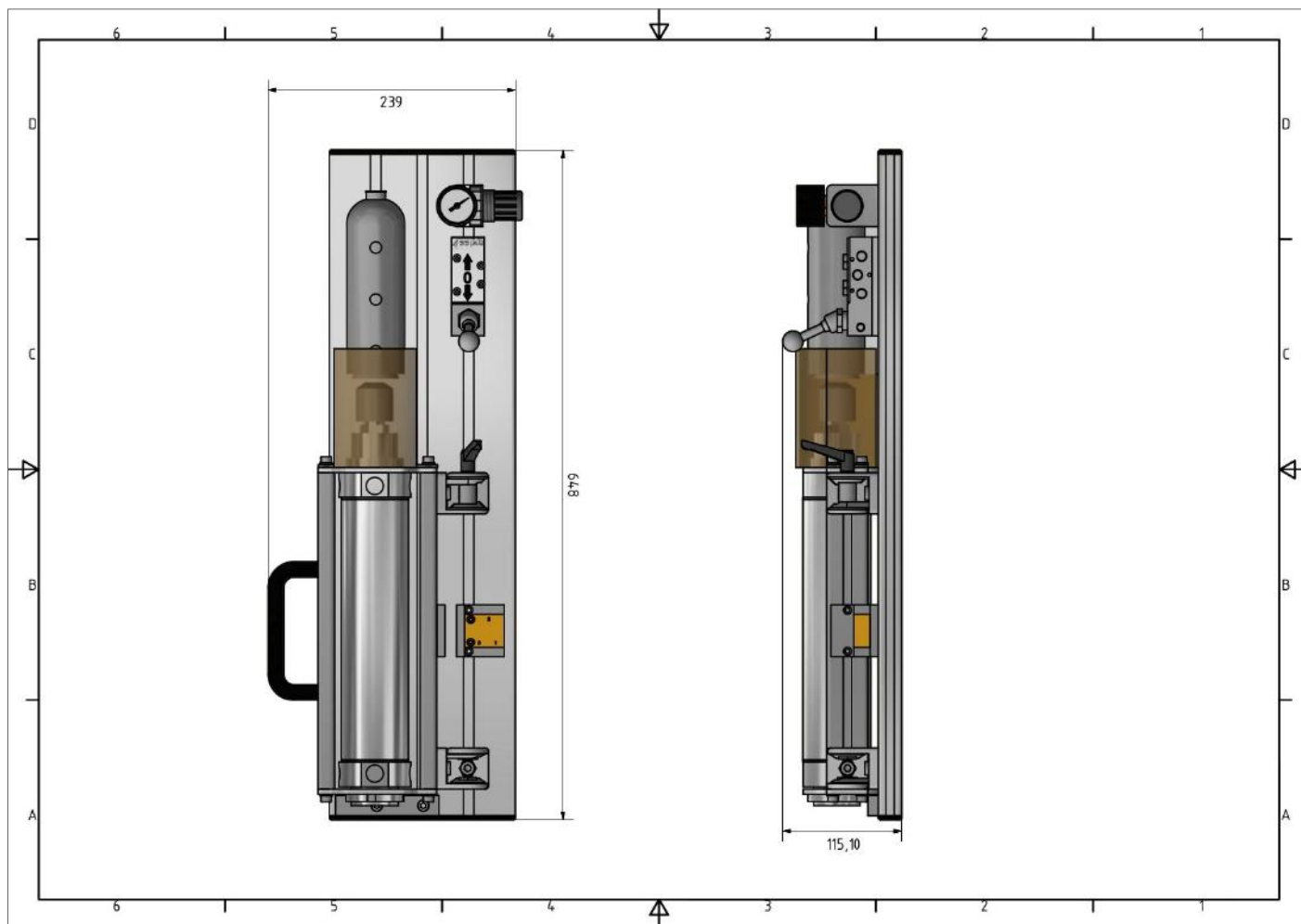

Cartridge size	Semco-cartridges 180 ml
Pressing device	Pneumatical cylinder with throttle valves
Protection	Safety valve (Stop pressured air)
Max. valid air pressure	6 bar
Pressure regulation	Pressure regulator with pressure gauge
Viscosity	Low to high viscous dosing media
Dimensions	648 x 239 x 115 mm
Weight	8 kg