

9112 Emptying system Semco 900 ml



7002-0004 Level sensor



5015 2-Way ball valve



5015-02 Ball valve with quick release and safety sheet

Description

Pneumatic emptying system for Semco cartridges 900 ml.

With folding mechanism for replacing the cartridges. The setting on the pressure gauge changes the pressure on the cartridge and thus the flow rate.

Connection options for different dosing valves such as e.g. Dispenser via a material tube.

9112 Emptying system Semco 900 ml

Dimensional drawing (Dimensions in mm)

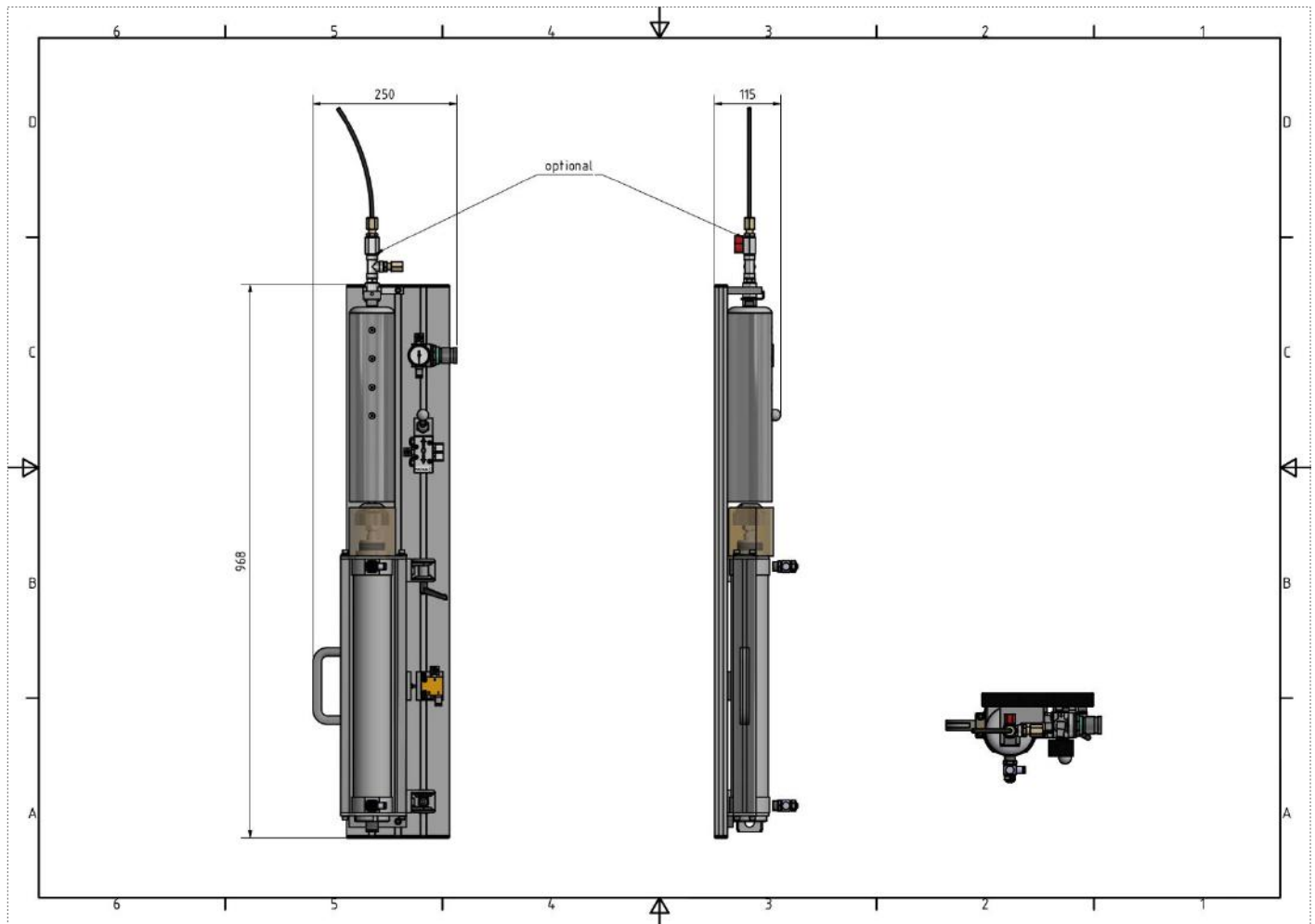

Cartridge size	Semco-cartridges 900 ml
Pressing device	Pneumatical cylinder with throttle valves
Protection	Safety valve (Stop pressured air)
Max. valid air pressure	6 bar
Pressure regulation	Pressure regulator with pressure gauge
Viscosity	Low to high viscous dosing media
Dimensions	968 x 250 x 115 mm
Weight	10 kg